

# T-LA Series User's Manual

Linear actuators



# Table of Contents

<b>1. Disclaimer</b>	1
<b>2. Precautions</b>	1
2.1. Lubrication	1
<b>3. Initial Setup and Testing</b>	1
<b>4. Installation</b>	2
4.1. Connection to a Computer	2
4.2. Data Cable Wiring Diagram	3
4.3. Connecting Vacuum Compatible Devices	4
4.4. Physical Installation	5
4.4.1. Mounting	5
4.4.2. Grounding	6
<b>5. Control Through The RS-232 Serial Port</b>	6
5.1. Examples	7
5.2. Data Conversion Algorithms	7
5.3. Sample Waveforms	8
<b>6. Quick Command Reference</b>	10
<b>7. Detailed Command Reference</b>	12
7.1. Reset - Cmd 0	12
7.2. Home - Cmd 1	13
7.3. Renumber - Cmd 2	13
7.4. Store Current Position - Cmd 16	14
7.5. Return Stored Position - Cmd 17	15
7.6. Move To Stored Position - Cmd 18	15
7.7. Move Absolute - Cmd 20	16
7.8. Move Relative - Cmd 21	17
7.9. Move At Constant Speed - Cmd 22	18
7.10. Stop - Cmd 23	19
7.11. Read Or Write Memory - Cmd 35	20
7.12. Restore Settings - Cmd 36	20
7.13. Set Microstep Resolution - Cmd 37	21

7.14. Set Running Current - Cmd 38 .....	22
7.15. Set Hold Current - Cmd 39 .....	23
7.16. Set Device Mode - Cmd 40 .....	24
7.17. Set Home Speed - Cmd 41 .....	28
7.18. Set Target Speed - Cmd 42 .....	29
7.19. Set Acceleration - Cmd 43 .....	30
7.20. Set Maximum Position - Cmd 44 .....	31
7.21. Set Current Position - Cmd 45 .....	32
7.22. Set Maximum Relative Move - Cmd 46 .....	33
7.23. Set Home Offset - Cmd 47 .....	33
7.24. Set Alias Number - Cmd 48 .....	34
7.25. Set Lock State - Cmd 49 .....	35
7.26. Return Device ID - Cmd 50 .....	36
7.27. Return Firmware Version - Cmd 51 .....	36
7.28. Return Power Supply Voltage - Cmd 52 .....	37
7.29. Return Setting - Cmd 53 .....	37
7.30. Return Status - Cmd 54 .....	38
7.31. Echo Data - Cmd 55 .....	39
7.32. Return Current Position - Cmd 60 .....	39
<b>8. Reply-Only Reference .....</b>	<b>40</b>
8.1. Move Tracking - Cmd 8 .....	40
8.2. Limit Active - Cmd 9 .....	41
8.3. Manual Move Tracking - Cmd 10 .....	41
8.4. Error - Cmd 255 .....	42
<b>9. Manual Control .....</b>	<b>44</b>
<b>10. LED functions .....</b>	<b>45</b>
<b>11. Troubleshooting T-Series Motion Devices .....</b>	<b>45</b>
<b>12. Warranty and Repair .....</b>	<b>48</b>
12.1. Standard products .....	48
12.2. Custom products .....	48
12.3. How to return products .....	49
<b>13. Email Updates .....</b>	<b>49</b>
<b>14. Contact Information .....</b>	<b>49</b>

<b>15. Appendix A: Default Settings</b> .....	49
<b>16. Product Drawing</b> .....	50
<b>17. Specifications</b> .....	51
17.1. Comparison .....	52
17.2. Charts and Notes .....	53

# 1. Disclaimer

Zaber's devices are not intended for use in any critical medical, aviation, or military applications or situations where a product's use or failure could cause personal injury, death, or damage to property. Zaber disclaims any and all liability for injury or other damages resulting from the use of our products.

# 2. Precautions

Zaber's motion control devices are precision instruments and must be handled with care. In particular, moving parts must be treated with care. Avoid axial loads in excess of the rated thrust load, axial and radial impact, dust and other contaminants and damage to the leadscrew thread. These will reduce the performance of the device below stated specifications.

## Special Note

The plunger should always be left in the fully retracted position (home) when not in use.

## 2.1. Lubrication

Performance depends very much on the condition of the leadscrew, so the leadscrew should be cleaned periodically for best results. To clean the screw, first use isopropyl alcohol to dissolve old grease and contaminants. There are plastic components that may be damaged by some strong solvents. Apply a small amount of grease. The grease will reduce friction, backlash and sticktion. We use NyeClean 5077 vacuum grease available from [www.nyelubricants.com](http://www.nyelubricants.com). A similar grease with a compatible thickener and lubricant are also suitable.

# 3. Initial Setup and Testing

If you are unfamiliar with T-series devices, you may wish to perform a few simple steps to familiarize yourself with their operation. First you will need a power supply. If you did not add one to your order, you will require a power supply that matches the voltage requirement of the device. Some T-series products, usually devices that run on 12 - 16 V, transmit power between devices through the data cables. The chosen power supply must be rated to handle the maximum total current draw of all devices connected to it. When powering long chains of devices, we recommend connecting a power supply to at least every 3rd device in the chain to reduce the current through the data cables. Devices that run on more than 16 V do not transmit power through the data cables.

Once you have a working power supply, you can test the operation of your device. Try turning the potentiometer (if applicable) counterclockwise to home the device. When operating manually, you should home the device by retracting it completely every time you disconnect or turn off the

power. You will not be able to achieve the maximum travel until you have homed the device or sent a command to tell the device its current position. After the device retracts completely it will stop automatically and you can turn the potentiometer clockwise to move the device. If you have a model without a potentiometer, you cannot control the device manually. Instead you must connect the device to a computer and issue a home instruction.

## 4. Installation

### 4.1. Connection to a Computer

Connect the device to a computer as follows:

1. Either plug the Mini-DIN to D-Sub serial adaptor (T-DSUB9) into your computer's serial port, or the Mini-DIN to USB adapter (T-USBDC) into one of your computer's USB ports, then plug the device's data cable into the adaptor. For the USB adaptor, new computers will often be able to install the necessary drivers automatically when the cable is plugged in for the first time. If the computer reports that the driver installation was unsuccessful, you can download the drivers for Windows, Mac, or Linux [here](#). Installation instructions and troubleshooting information are available for each operation system [here](#). You may need to use a cable extension to reach your computer. There is no need to power-down or reboot the computer.
2. Connect the power plug of your power supply to the power connector of the device (figure 2). If present, the green LED should light up indicating the device has power (some devices may not have LEDs).
3. If your device comes with a knob for manually adjusting the actuator's position, set the knob to the neutral position between forward and backward. At this point, you will feel a slight detent and the yellow light (if present) will turn off. For the device to receive computer commands, the manual knob must be in the neutral position.
4. Additional devices can simply be daisy-chained to the first (figure 3). For long chains of devices that daisy chain power, a power supply should be connected at every 2nd or 3rd device. A renumber command needs to be issued after a new device is connected, before it can be controlled independently.
5. Install software from <https://www.zaber.com/wiki/Software> (figure 4). We recommend installing the Zaber Console to get started. As a simple first test, try entering these instructions:

```
Renumber all devices           - Device: 0, Cmd: 2, Data: 0
Home device 1                  - Device: 1, Cmd: 1, Data: 0
Move device 1 to 10,000 microsteps - Device: 1, Cmd: 20, Data: 10000
```

To see the microstep distance (resolution) for your device, see the specs page for that device on the respective product page.

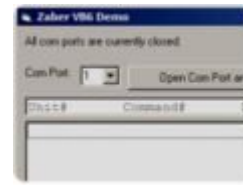

## 4.2. Data Cable Wiring Diagram

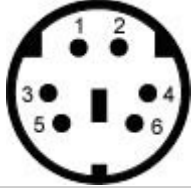
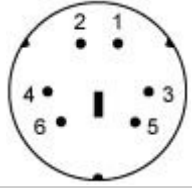
Pin#	Minidin 6 Female (to next device)	Minidin 6 Male (to previous device)
		
1	-	-
2	Receive (from next device)	Transmit (toward computer)
3	Ground	Ground
4	+12-16 Vdc *	+12-16 Vdc *
5	-	-
6	Transmit (to next device)	Receive (from computer)
nc	-	-

Note that multiple cable suppliers have been used over the years, each implementing different color codes. Rather than relying on the wire colors, it is recommended that users perform a continuity test to determine which wires are connected to which pins on their own device.

To connect a Zaber device to a computer serial port requires a T-DSUB9 adaptor. It looks similar to an old PS/2 serial mouse adaptor, but it has different wiring.

### 4.3. Connecting Vacuum Compatible Devices

These Zaber products are available in a vacuum compatible version. Vacuum compatible devices (identifiable by the suffix "-V" in the part number) have special requirements for their connection to a computer.

**Power:** No power connectors are provided on vacuum compatible devices. Instead, power must be supplied through the data cable lines. A special serial adapter with power input is provided.

**Data Cables:** Vacuum compatible devices use the same mini-din data cable extensions as our standard devices; however, the cable jacket is stripped back to the connectors to expose the individual wires. The mini-din connectors are left attached to facilitate easy testing. In your final application you can cut the wires and splice them to a feed-through on your vacuum chamber.

Communication lines can be wired back to the appropriate mini-din connector outside your vacuum chamber. Power lines can be wired to any appropriate power supply. See the table below for pinouts. If you have multiple units inside the same vacuum chamber you may connect them using the attached mini-din connectors, or for improved vacuum compatibility you may remove the connectors and permanently wire the units together.

**Grounding:** When re-wiring Zaber devices it is important to wire the ground to both the computer and the power supply (see diagram below). Alternately, the T-DSUB9-P vacuum adaptor can be substituted into an order to make this connection.



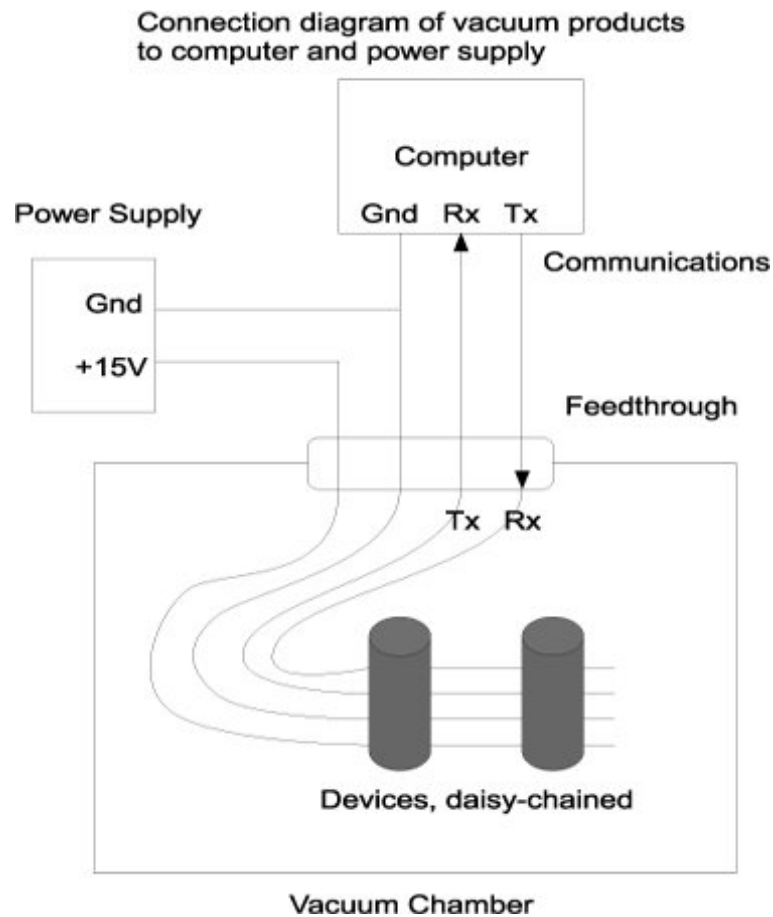

## 4.4. Physical Installation

### 4.4.1. Mounting

When mounting a Zaber linear actuator, care must be taken not to over-constrain the leadscrew. At the point of contact between the leadscrew and the object to be moved there are 6 degrees of freedom which can be constrained: translation along xyz axes and rotation about those axes. The load should constrain only the axial translation of the leadscrew. The simplest way to achieve this is to have the lead screw press against a flat surface perpendicular to the axis of the leadscrew. Any further constraint (such as rigidly fixing the leadscrew to the load) may result in an over-constrained system that will reduce thrust or cause the leadscrew to bind.

You can mount the actuator by sliding the 9.5mm mounting shank through the hole on a translation stage (like our TSB stages). Tighten a clamp around the shank or secure the included 3/8-32 screw on the other side of the hole. Some actuators also have mounting holes on the side or bottom of the actuator, and come with mounting screws.

#### 4.4.2. Grounding

To prevent damage to the device due to static buildup, the device should be properly grounded.

Failure to ground the unit may result in the unit shutting down unexpectedly or ceasing to communicate with the computer. This problem can be minimized by not touching the unit during operation. If the unit fails due to static discharge, unplugging it and plugging it back in or sending a Restore Settings command will usually fix the problem.

Most Zaber devices are grounded via the shield wire of the data cables. This should normally provide a path to ground via the computer. For units which are being used without a computer, a ground lead should be connected to the shield of one of the data cables.

The T-LA is particularly sensitive to static discharge at the front mount. For best results, avoid touching the front mount of the T-LA while the device is in operation.

## 5. Control Through The RS-232 Serial Port

All T-Series devices use the same RS232 communications protocol. Your communications settings must be: 9600 baud, no hand shaking, 8 data bits, no parity, one stop bit. The yellow LED will light when there is activity on the RS232 lines. You may use this feature to determine which COM port you are connected to. We recommend using the Zaber Console that you can download from our web site. The source code is also available for you to use as an example for writing your own custom code. See the troubleshooting section later in this manual if you have trouble communicating with the device.

Important: The first time you connect a device to your computer you must issue a renumber instruction to assign each device a unique identifier. This should be done after all the devices in the daisy-chain are powered up. In older firmware versions (prior to version 5xx) you must issue a renumber instruction after each powerup. In firmware 5xx and up, the device number is stored in non-volatile memory and will persist after powerdown, so you need only issue the renumber instruction when you add new devices to the chain, or rearrange the order of the devices, however it does no harm to issue the renumber instruction after every powerup. You must not transmit any instructions while the chain is renumbering or the renumbering routine may be corrupted. Renumbering takes less than a second, after which you may start issuing instructions over the RS232 connection.

All instructions consist of a group of 6 bytes. They must be transmitted with less than 10 ms between each byte. If the device has received less than 6 bytes and then a period longer than 10 ms passes, it ignores the bytes already received. We recommend that your software behave similarly when receiving data from the devices, especially in a noisy environment like a pulsed laser lab.

The following table shows the instruction format:

- Byte 1 - Device #
- Byte 2 - Command #
- Byte 3 - Data - Least Significant Byte (LSB)

- Byte 4 - Data
- Byte 5 - Data
- Byte 6 - Data - Most Significant Byte (MSB)

The first byte is the device number in the daisy-chain. Device number 1 is the closest device to the computer and device number 2 is next and so on. If the number 0 is used, all the devices in the chain will process the accompanying command simultaneously.

The second byte is the command number. Bytes 3, 4, 5, and 6 are data in long integer, 2's complement format with the least significant byte transmitted first. How the command data are interpreted depends on the command. Complete details are given in the command reference on the following page.

## 5.1. Examples

- All devices renumber: 0, 2, 0, 0, 0, 0
- All devices home: 0, 1, 0, 0, 0, 0
- All devices return firmware version: 0, 51, 0, 0, 0, 0
- Device 1 move to an absolute position (command 20) of 257 microsteps: 1, 20, 1, 1, 0, 0
- Device 2 move to a relative position (command 21) of -1 microstep: 2, 21, 255, 255, 255, 255

Most instructions cause the device to reply with a return code. It is also a group of 6 bytes. The first byte is the device #. Byte #2 is the instruction just completed or 255 (0xFF) if an error occurs. Bytes 3, 4, 5 and 6 are data bytes in the same format as the instruction command data.

## 5.2. Data Conversion Algorithms

If you are writing software to control Zaber products, you'll likely need to generate data bytes 3 through 6 from a single data value, or vice versa. The following pseudo-code can be used as a model.

Converting command data into command bytes to send to Zaber products

```

If Cmd_Data < 0 then Cmd_Data = 256^4 + Cmd_Data
    'Handles negative data
Cmd_Byte_6 = Cmd_Data / 256^3
Cmd_Data   = Cmd_Data - 256^3 * Cmd_Byte_6
Cmd_Byte_5 = Cmd_Data / 256^2
Cmd_Data   = Cmd_Data - 256^2 * Cmd_Byte_5
Cmd_Byte_4 = Cmd_Data / 256
Cmd_Data   = Cmd_Data - 256 * Cmd_Byte_4
Cmd_Byte_3 = Cmd_Data

```

## Converting reply bytes into a single reply data value

```
Reply_Data = 256^3 * Rpl_Byte_6 + 256^2 * Rpl_Byte_5 + 256 * Rpl_Byte_4 +  
Rpl_Byte_3  
If Rpl_Byte_6 > 127 then Reply_Data = Reply_Data - 256^4  
    'Handles negative data
```

### 5.3. Sample Waveforms

If you are designing hardware to interface with Zaber products, it may be useful to see some sample waveforms.

This image shows an instruction (top waveform) and a reply (bottom waveform).

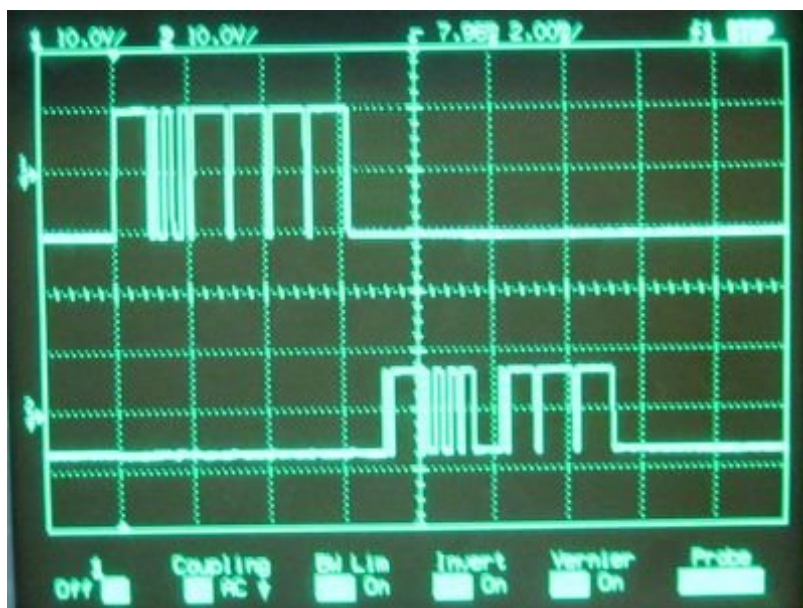

This is a closeup of the instruction bytes. Note that the voltage swing of the instruction waveform is about +/-10V. This is typical of the USB to RS232 converter to which the device is connected. The instruction bytes are 0, 51, 0, 0, 0, 0 indicating the instruction: Device: All, Command: Return version, Data: 0.

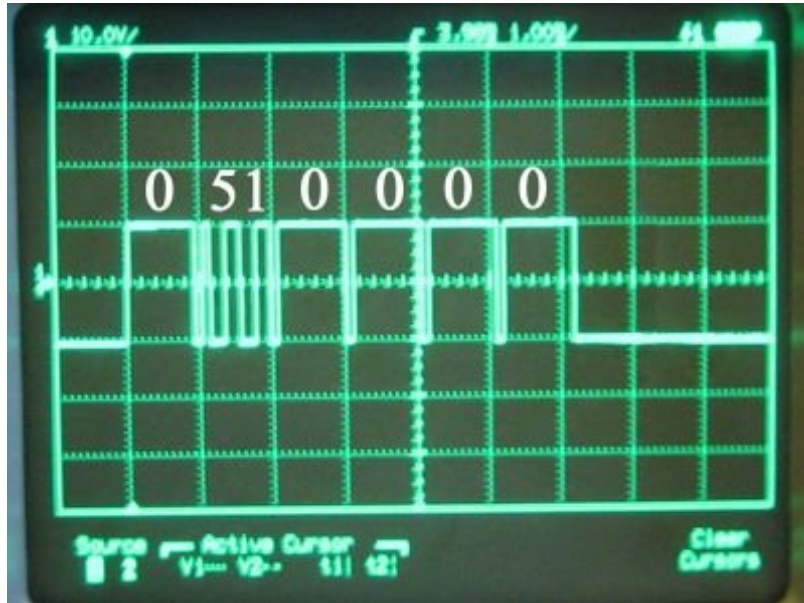

This is a closeup of the instruction byte 2. The "S" on either end represents the start and stop bits respectively. The start bit is always positive and the stop bit is always negative. The bit sequence is Start, 0, 1, 2, 3, 4, 5, 6, 7, Stop. The data is output with the least significant bit first, so the byte shown is actually 00110011 in binary or  $32+16+2+1 = 51$  in decimal.

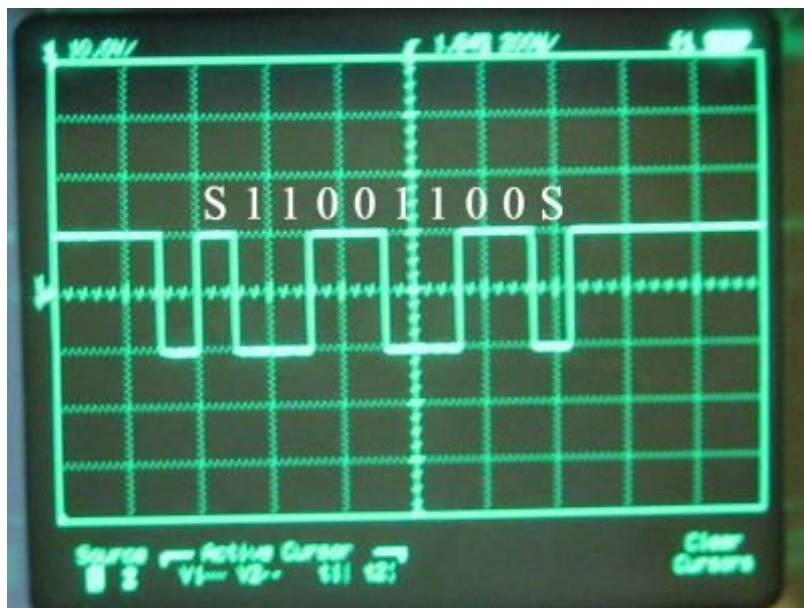

This is a closeup of the reply bytes. Note that the voltage swing of the reply waveform is about +/-8V. This is a typical output from the RS232 driver chip used in Zaber devices. The instruction was to all devices. Only a single device is present so there is only one reply. The reply is 1, 51, 252, 1, 0, 0 indicating the reply "Device: 1, Reply: Firmware version, Data: 508". The data is the last 4 bytes combined, with least significant byte first. In this case the data is  $0*256^3 + 0*256^2 + 1*256 + 252 = 508$ . This indicates a firmware version of 5.08 since according to the instruction specification a decimal is assumed before the last two digits.



## 6. Quick Command Reference

The following table offers a quick command reference for motorized devices running firmware version 5xx. For convenience, you may sort the table below by instruction name, command number, or reply number. Follow the links to view a detailed description of each instruction.

Instruction Name	Command#	Command Data	Command Type	Reply Data
Reset	0	Ignored	Command	None
Home	1	Ignored	Command	Final position (in this case 0)
Renumber*	2	Ignored	Command	Device ID
Move Tracking	8	n/a	Reply	Tracking Position
Limit Active	9	n/a	Reply	Final Position
Manual Move Tracking	10	n/a	Reply	Tracking Position
Store Current Position*	16	Address	Command	Address
Return Stored Position	17	Address	Command	Stored Position
Move To Stored Position	18	Address	Command	Final Position
Move Absolute	20	Absolute Position	Command	Final Position
Move Relative	21	Relative Position	Command	Final Position

Move At Constant Speed	22	Speed	Command	Speed
Stop	23	Ignored	Command	Final Position
Read Or Write Memory*	35	Data	Command	Data
Restore Settings*	36	Peripheral ID	Command	Peripheral ID
Set Microstep Resolution*	37	Microsteps	Setting	Microsteps
Set Running Current*	38	Value	Setting	Value
Set Hold Current*	39	Value	Setting	Value
Set Device Mode*	40	Mode	Setting	Mode
Set Home Speed*	41	Speed	Setting	Speed
Set Target Speed*	42	Speed	Setting	Speed
Set Acceleration*	43	Acceleration	Setting	Acceleration
Set Maximum Position*	44	Range	Setting	Range
Set Current Position	45	New Position	Setting	New Position
Set Maximum Relative Move*	46	Range	Setting	Range
Set Home Offset*	47	Offset	Setting	Offset
Set Alias Number*	48	Alias Number	Setting	Alias Number
Set Lock State*	49	Lock Status	Command	Lock Status
Return Device ID	50	Ignored	Read-Only Setting	Device ID
Return Firmware Version	51	Ignored	Read-Only Setting	Version
Return Power Supply Voltage	52	Ignored	Read-Only Setting	Voltage
Return Setting	53	Setting Number	Command	Setting Value
Return Status	54	Ignored	Read-Only Setting	Status
Echo Data	55	Data	Command	Data
Return Current Position	60	Ignored	Read-Only Setting	Position
Error	255	n/a	Reply	Error Code

\* The settings for these commands are saved in non-volatile memory, i.e. the setting persists even if the device is powered down. To restore all settings to factory default, use command 36.

## 7. Detailed Command Reference

This command reference applies only to firmware version 5.00 and up to the most recent version. The version of firmware installed on any Zaber T-Series device can be determined by issuing command #51. A three-digit number will be returned. Assume 2 decimal places (ex a reply of 293 indicates firmware version 2.93). For earlier versions of firmware, please consult the appropriate PDF user's manual:

[T-Series Manual 2xx \(PDF\)](#)

[T-Series Manual 4xx \(PDF\)](#)

Due to the addition of new features, newer versions of firmware may not be 100% backward compatible. You may wish to read the document [Firmware History and Migration](#) which outlines the changes that have taken place from one firmware version to the next and indicates what options are available if you wish to upgrade or downgrade the firmware on your devices.

### 7.1. Reset - Cmd 0

Instruction Name	Reset
Applies to	All Zaber devices
Firmware Version	5.00 and up
Command Number	0
Command Type	Command
Command Data	Ignored
Reply Data	None
Safe to retry?	Yes
Returns Current Position?	No
Persistence	n/a
Summary	Sets the device to its power-up condition.

This has the same effect as unplugging and restarting the device.

#### Special Note

The position stored in the device prior to this command will be lost, so you must save it and reload it if it is important. All non-volatile settings (i.e. Device Number, Target Velocity, etc.) are saved and are not affected by reset or power-down.



## 7.2. Home - Cmd 1

Instruction Name	Home
Applies to	T-Series motorized devices
Firmware Version	5.xx
Command Number	1
Command Type	Command
Command Data	Ignored
Reply Data	Final Position
Safe to retry?	Yes
Returns Current Position?	Yes
Persistence	n/a
Summary	Moves to the home position and resets the device's internal position.

Upon receiving this instruction, the device will retract until its internal home sensor is triggered. It will then move forward several steps to avoid accidentally re-triggering the home sensor during use. Its internal position is then reset (to 0 for most devices). If a home offset has been specified with the Set Home Offset (cmd 47) instruction, the device will move forward for the specific offset, then reset the internal position.

Prior to Firmware 5.21, the device will attempt to home for an extended amount of time. For Firmware 5.21 and up, the home command aborts with an error if the device has traveled twice the Maximum Position setting without triggering the home sensor. This indicates that the device could possibly be stalling or slipping.

## 7.3. Renumber - Cmd 2

Instruction Name	Renumber
Applies to	All Zaber devices
Firmware Version	5.00 and up
Command Number	2
Command Type	Command
Command Data	New Number
Reply Data	Device ID

Safe to retry?	Yes
Returns Current Position?	No
Persistence	Non-Volatile
Summary	Assigns new numbers to all the devices in the order in which they are connected.

This command is usually sent to device number 0. When it is, the command data is ignored and all devices will renumber. The device closest to the computer becomes device number 1. The next device becomes number 2 and so on.

If sent to a device number other than 0, then that device will reassign itself the device number in the command data. Valid device numbers are 1-99 for version 6.05, and 1-254 otherwise.

Note: Renumbering takes about 1/2 a second during which time the computer must not send any further data. The device number is stored in non-volatile memory so you can renumber once and not worry about issuing the renumber instruction again after each power-up.

#### 7.4. Store Current Position - Cmd 16

Instruction Name	Store Current Position
Applies to	All motorized devices
Firmware Version	5.04 and up
Command Number	16
Command Type	Command
Command Data	Address
Reply Data	Address
Safe to retry?	Yes
Returns Current Position?	No
Persistence	Non-Volatile
Summary	Saves the current absolute position of the device.

Valid Address values are 0 through 15 specifying one of 16 possible registers in which to store the position. This command can only be executed when the device has been homed. This command is used in conjunction with the Return Stored Position (Command #17) and Move To Stored Position (Command #18) instructions. The positions stored in the position registers are non-volatile and will persist after power-down or reset. All position registers are cleared by the Restore Settings (Command #36) instruction.

## 7.5. Return Stored Position - Cmd 17

Instruction Name	Return Stored Position
Applies to	All motorized devices
Firmware Version	5.04 and up
Command Number	17
Command Type	Command
Command Data	Address
Reply Data	Stored Position
Safe to retry?	Yes
Returns Current Position?	No
Persistence	n/a
Summary	Returns the position stored in one of the 16 position registers for the device.

Valid command data values are 0 through 15, specifying one of 16 possible registers from which to retrieve the position. This command is used in conjunction with the Store Current Position (#16) and Move To Stored Position (#18) commands. Positions stored in the position registers are non-volatile and will persist after power-down or reset. All position registers are cleared by the Restore Settings (#36) command.

## 7.6. Move To Stored Position - Cmd 18

Instruction Name	Move To Stored Position
Applies to	All motorized devices
Firmware Version	5.04 and up
Command Number	18
Command Type	Command
Command Data	Address
Reply Data	Final Position
Safe to retry?	Yes
Returns Current Position?	Yes
Persistence	n/a
Summary	Moves the device to the stored position specified by the Command Data.

Valid address values are 0 through 15, specifying one of 16 possible positions. This command is used in conjunction with the Store Current Position (#16) and Return Stored Position (#17) commands. This command does not send a response until the move has finished. All move commands are pre-emptive. If a new move command is issued before the previous move command is finished, the device will immediately move to the new position.

The target speed and acceleration during a move absolute instruction can be specified using Set Target Speed (Cmd 42) and Set Acceleration (Cmd 43) respectively.

This command may pre-empt, or be pre-empted by Move to Stored Position (Cmd 18), Move Absolute (Cmd 20), Move Relative (Cmd 21), Move at Constant Speed (Cmd 22), Move Index (Cmd 78) and Stop (Cmd 23).

## 7.7. Move Absolute - Cmd 20

Instruction Name	Move Absolute
Applies to	T-Series motorized devices
Firmware Version	5.xx
Command Number	20
Command Type	Command
Command Data	Absolute Position
Reply Data	Final Position
Safe to retry?	Yes
Returns Current Position?	Yes
Persistence	n/a
Summary	Moves the device to the position specified in the Command Data in microsteps.

The device begins to move immediately, and sends a response when the move has finished. The position must be between 0 and Maximum Position (specified by Set Maximum Position (cmd 44)), or an error code will be returned.

The target speed and acceleration during a move absolute instruction can be specified using Set Target Speed (Cmd 42) and Set Acceleration (Cmd 43) respectively.

All move commands are pre-emptive. If a new move command is issued before the previous move command is finished, the device will immediately move to the new position. This command may pre-empt, or be pre-empted by Move to Stored Position (Cmd 18), Move Absolute (Cmd 20), Move Relative (Cmd 21), Move at Constant Speed (Cmd 22) and Stop (Cmd 23).

## 7.8. Move Relative - Cmd 21

Instruction Name	Move Relative
Applies to	T-Series motorized devices
Firmware Version	5.xx
Command Number	21
Command Type	Command
Command Data	Relative Position
Reply Data	Final Position
Safe to retry?	No
Returns Current Position?	Yes
Persistence	n/a
Summary	Moves the device by the positive or negative number of microsteps specified in the Command Data.

The device moves to a position given by its current position plus the value specified in the command data. The relative move command data in microsteps can be positive or negative. The final position must be between 0 and Maximum Position (specified by Set Maximum Position (cmd 44)), or an error code will be returned. The device begins to move immediately, and sends a response when the move has finished.

The target speed and acceleration during a move absolute instruction can be specified using Set Target Speed (Cmd 42) and Set Acceleration (Cmd 43) respectively.

All move commands are pre-emptive. If a new move command is issued before the previous move command is finished, the device will immediately move to the new position. If a Move Relative command is issued while the device is currently moving due to a previous command, the device will immediately set a new target position equal to the current position (at the instant the command was received) plus the specified relative position.

This command may pre-empt, or be pre-empted by Move to Stored Position (Cmd 18), Move Absolute (Cmd 20), Move Relative (Cmd 21), Move at Constant Speed (Cmd 22) and Stop (Cmd 23).

## 7.9. Move At Constant Speed - Cmd 22

Instruction Name	Move At Constant Speed
Applies to	T-Series motorized devices
Firmware Version	5.xx
Command Number	22
Command Type	Command
Command Data	Speed
Reply Data	Speed
Safe to retry?	Yes
Returns Current Position?	No
Persistence	n/a
Summary	Moves the device at a constant speed based on the value specified in the Command Data.

This instruction specifies a direction and a speed to move, rather than a target position. When this instruction is issued the device will accelerate (at a rate determined by command #43 Set Acceleration) to the speed specified by the instruction data. The device will continue moving at this speed until a limit is reached or a pre-empting instruction is issued. Negative speeds cause retraction while positive speeds cause extension. Unlike the other movement commands, this command sends a response immediately without waiting for the move to finish.

The device may be set to return its position continuously during the move using the set mode command (#40) bit 4. Position tracking is a reply-only command #8. If the device runs into zero position or maximum range, the device stops and the new position is returned via reply-only command #9.

This command may pre-empt, or be pre-empted by commands 18, 20, 21, 22 and 23.

For a spreadsheet that can be used to calculate speed setting values for any product see <https://www.zaber.com/documents/ZaberSpeedSetting.xls>. Alternatively you may use the formulas below.

### Actual Speed

$$= \text{Data} * 9.375 * M \quad \text{mm/s or deg/s}$$

$$= \text{Data} * 9.375 \quad \text{microsteps/s}$$

$$= \text{Data} * 9.375 / R \quad \text{steps/s}$$

$$= \text{Data} * 9.375 / (R * S) * 60 \quad \text{revolutions/min} \quad \text{Motor rpm}$$

$$= \text{Data} * 9.375 * L / (R * S) \quad \text{mm/s} \quad \text{Linear devices only}$$

where:

- Data is the value of the command data
- R (microsteps/step) is the microstep resolution (command 37)
- S (steps/revolution) is the number of steps per motor revolution
- M (mm or deg) is the microstep size
- L (mm or deg) is the distance of linear motion per motor revolution

Refer to product specifications for the distance corresponding to a single microstep or revolution.

For example, if a motor has 48 steps per revolution ( $S = 48$ ), used with default resolution ( $R = 64$ ), and Data is 2922, then the motor will move at a speed of approximately 535 revolutions per minute.

Valid data values are from  $(-512 \times R - 1)$  to  $(512 \times R - 1)$ . Note that a value of zero will cause the device to decelerate to a stop and then send Limit Active (Cmd 9).

## 7.10. Stop - Cmd 23

Instruction Name	Stop
Applies to	T-Series motorized devices
Firmware Version	5.xx
Command Number	23
Command Type	Command
Command Data	Ignored
Reply Data	Final Position
Safe to retry?	Yes
Returns Current Position?	Yes
Persistence	n/a
Summary	Stops the device from moving by preempting any move instruction.

This instruction can be used to pre-empt any move instruction. The device will decelerate to a stop. The reply data is the absolute position after stopping.

The device will decelerate at a rate specified by Set Acceleration (Cmd 43).

This command may pre-empt, or be pre-empted by Move to Stored Position (Cmd 18), Move Absolute (Cmd 20), Move Relative (Cmd 21), Move at Constant Speed (Cmd 22) and Stop (Cmd 23).

## 7.11. Read Or Write Memory - Cmd 35

Instruction Name	Read Or Write Memory
Applies to	T-Series motorized devices
Firmware Version	5.xx
Command Number	35
Command Type	Command
Command Data	Data
Reply Data	Data
Safe to retry?	Yes
Returns Current Position?	No
Persistence	Non-Volatile
Summary	Reads or writes a byte of non-volatile memory.

128 bytes of memory are available for user data. For example, the user may want to save some custom data such as a serial number, a name string, or data that uniquely identifies a particular device. Data written is not cleared by power down or reset. The most significant bit of byte 3 specifies whether the instruction is a read (0) or a write (1). The least significant 7 bits of byte 3 specify the address to read/write (0 to 127). Byte 4 specifies the value to be written. Bytes 5 and 6 are ignored.

These settings are stored in non-volatile memory and will persist after power-down or reset.

## 7.12. Restore Settings - Cmd 36

Instruction Name	Restore Settings
Applies to	All Zaber devices except controllers
Firmware Version	5.00 and up
Command Number	36
Command Type	Command
Command Data	Peripheral ID
Reply Data	Peripheral ID
Safe to retry?	Yes
Returns Current Position?	No



Persistence	Non-Volatile
Summary	Restores the device settings to the factory defaults.

This command should be issued with a peripheral ID of 0 to return the device to factory default settings. This instruction is very useful for troubleshooting. If the device does not appear to function properly, it may be because some of the settings have been changed. This instruction will restore the settings to default values. For a table of default settings, see Appendix A. All settings affected by this instruction are stored in non-volatile memory and will persist after power-down or reset.

### 7.13. Set Microstep Resolution - Cmd 37

Instruction Name	Set Microstep Resolution
Applies to	T-Series motorized devices
Firmware Version	5.xx
Command Number	37
Command Type	Setting
Command Data	Microsteps
Reply Data	Microsteps
Safe to retry?	Yes
Returns Current Position?	No
Persistence	Non-Volatile
Summary	Changes the number of microsteps per step.

This command sets the microstep resolution of a device.

This setting is stored in non-volatile memory and will persist after power-down or reset. Use Restore Settings (Cmd 36) to restore all non-volatile settings to factory default.

The default on most devices is 64. Available microstep resolutions are:

1, 2, 4, 8, 16, 32, 64, 128

All position data sent to or received from T-Series products is in units of microsteps. Note that when you change the microstep resolution, other position related settings are scaled automatically from current values to adjust for the new microstep size. The table below gives an example showing how other settings are affected when the microstep resolution is changed from 128 to 64:

Setting	Before	After
Target Speed *	2922	1461
Maximum Travel Range *	280000	140000
Current Position	10501 **	5250 **
Maximum Relative Move *	20000	10000
Home Offset *	1000	500
Acceleration *	100	50

\* The settings for these commands are saved in non-volatile memory.

\*\* Note that if a number is divided by two, it is rounded down to the nearest whole number. The only exception to this is if acceleration would become 0 (because 0 for acceleration indicates infinite acceleration). If acceleration would become 0, it will instead be set to 1 which is the lowest acceleration possible.

## 7.14. Set Running Current - Cmd 38

Instruction Name	Set Running Current
Applies to	T-series motorized devices (excluding T-LSQ, T-LST, T-MCA)
Firmware Version	5.xx
Command Number	38
Command Type	Setting
Command Data	Value
Reply Data	Value
Safe to retry?	Yes
Returns Current Position?	No
Persistence	Non-Volatile
Summary	Sets the desired current to be used when the device is moving.

If your application does not require high torque, it is best to decrease the driving current to reduce power consumption, vibration, and motor heating. Trial and error should suggest an appropriate setting. If higher torque is required, it is generally safe to overdrive motors as long as they are not operated continuously. Motor temperature is typically the best indication of the degree to which overdriving can be employed. If the motor gets too hot to touch (>75°C), you should reduce the running current.

The current is related to the data by the formula:

$$\text{Current} = \text{CurrentCapacity} * 10 / \text{CommandData}$$

The range of accepted values is 0 (no current), 10 (max) - 127 (min). CurrentCapacity is the hardware's maximum capability of output current.

To prevent damage, some devices limit the maximum output current to a lower value. In that case the valid range is 0, Limit - 127. Current limits are listed under the device specifications.

Some devices limit the voltage rather than the current. In this case the same formula can be used by replacing Current and CurrentCapacity with Voltage and PowerSupplyVoltage.

For example, Suppose you connect a stepper motor rated for 420mA per phase to a T-CD2500. Reversing the equation above and using 420mA as Current gives:

CommandData

$$\begin{aligned} &= 10 * \text{CurrentCapacity} / \text{Current} \\ &= 10 * 2500\text{mA} / 420\text{mA} \\ &= 59.5 \text{ (round to 60)} \end{aligned}$$

Therefore CommandData = 60.

## 7.15. Set Hold Current - Cmd 39

Instruction Name	Set Hold Current
Applies to	T-series motorized devices (excluding T-LSQ, T-LST, T-MCA)
Firmware Version	5.xx
Command Number	39
Command Type	Setting
Command Data	Value
Reply Data	Value
Safe to retry?	Yes
Returns Current Position?	No
Persistence	Non-Volatile
Summary	Sets the desired current to be used when the device is holding its position.

It is typical to run stepper motors at their rated current only during moves (for highest torque) and reduce the current when idle just to hold the position.

Typically the hold current can be set to around 25 - 50% of the running current. In some applications, the friction of the drive system alone is sufficient to hold the microstep position of the motor, and the hold current can be turned off completely. The hold current can be turned off by issuing the "Set Hold Current" instruction with data of 0.

When the device is moving, it applies running current to the motor. When the device stops

moving, running current is applied for an additional 0.1 second before hold current is applied.

The current is related to the data by the formula:

$$\text{Current} = \text{CurrentCapacity} * 10 / \text{CommandData}$$

The range of accepted values is 0 (no current), 10 (max) - 127 (min). CurrentCapacity is the hardware's maximum capability of output current.

To prevent damage, some devices limit the maximum output current to a lower value. In that case the valid range is 0, Limit - 127. Current limits are listed under the device specifications.

Some devices limit the voltage rather than the current. In this case the same formula can be used by replacing Current and CurrentCapacity with Voltage and PowerSupplyVoltage.

For example, Suppose you connect a stepper motor rated for 420mA per phase to a T-CD2500. Reversing the equation above and using 420mA as Current gives:

CommandData

$$\begin{aligned} &= 10 * \text{CurrentCapacity} / \text{Current} \\ &= 10 * 2500\text{mA} / 420\text{mA} \\ &= 59.5 \text{ (round to 60)} \end{aligned}$$

Therefore CommandData = 60.

## 7.16. Set Device Mode - Cmd 40

Instruction Name	Set Device Mode
Applies to	T-Series motorized devices
Firmware Version	5.xx since 5.04
Command Number	40
Command Type	Setting
Command Data	Mode
Reply Data	Mode
Safe to retry?	Yes
Returns Current Position?	No
Persistence	Non-Volatile
Summary	Sets the Mode for the given device.

This command allows setting several options. Each option is controlled by a single bit within the command data. Most software you will encounter, including most of our demo software, represents all 4 data bytes as a single decimal value rather than specifying each bit individually. To determine what decimal value to use requires a basic understanding of how the data is represented in binary. The command data may be considered as a single 32-bit binary value. The

least significant bit is bit\_0, the next is bit\_1, the next is bit\_2, and so on up to the most significant bit\_31. Each bit may have a value of either 1 or 0.

The corresponding decimal representation of this 32-bit data is given by:

$$\text{Decimal value} = (\text{bit}_0 * 1) + (\text{bit}_1 * 2) + \dots + (\text{bit}_n * 2^n) + \dots + (\text{bit}_{31} * 2^{31})$$

Each bit controls a single mode option as described in the table below. To determine the data value to use with the Set Device Mode command, simply determine the desired value of each bit (1 or 0), and calculate the decimal value using the above formula. Note that not all 32 bits are currently used. Any unused or reserved bits should be left as 0.

For example, suppose you want all mode bits to be 0 except for bit\_3 (disable potentiometer), bit\_14 (disable power LED), and bit\_15 (disable serial LED). The Set Device Mode instruction should be sent with data calculated as follows:

$$\text{Command Data} = 2^3 + 2^{14} + 2^{15} = 8 + 16384 + 32768 = 49160$$

Note that each instance of the Set Device Mode command overwrites ALL previous mode bits. Repeated commands do not have a cumulative effect. For example, suppose you send a Set Device Mode command with data of 8 to disable the potentiometer. If you then send another Set Device Mode command with data of 16384 to disable the power LED, you will re-enable the potentiometer since bit\_3 in the 2nd instruction is 0.

Most devices have a default mode setting of 0 (all bits are 0), however, there are some exceptions. See Appendix A of the user manual for a table of default settings.

Bit_n	2^n	Description
bit_0	1	Disable Auto-reply A value of 1 disables ALL replies except those to "echo", "read", "renumber", and "return" commands. The default value is 0 on all devices.
bit_1	2	Enable Anti-backlash Routine A value of 1 enables anti-backlash. On negative moves (retracting), the device will overshoot the desired position by 640 microsteps (assuming 64 microsteps/step), reverse direction and approach the requested position from below. On positive moves (extending), the device behaves normally. Care must be taken not to crash the moving payload into a fixed object due to the 640 microsteps overshoot on negative moves. The default value is 0 on all devices. See note on anti-backlash and anti-sticktion below. *
bit_2	4	Enable Anti-sticktion Routine A value of 1 enables the anti-sticktion routine. On moves less than 640 microsteps (assuming 64 microsteps/step), the device will first retract to a position 640 microsteps less than the requested position and approach the requested position from below. Care must be taken not to crash the moving payload into a fixed object due to the 640 microsteps negative move. The default value is 0 on all devices. See section on anti-backlash and anti-sticktion below this table. *
bit_3	8	Disable Potentiometer A value of 1 disables the potentiometer preventing manual adjustment of the device. The default value is 0 on all devices.

<b>bit_4</b>	16	<p>Enable Move Tracking</p> <p>A value of 1 enables the Move Tracking response during move commands. The device will return its position periodically (every 0.25 sec) when a move command is executed. The Disable Auto-Reply option above takes precedence over this option. The default value is 0 on all devices. Before firmware version 5.14, only Move at Constant Speed commands could generate tracking responses, now all move commands can.</p>
<b>bit_5</b>	32	<p>Disable Manual Move Tracking</p> <p>A value of 1 disables the Manual Move Tracking response during manual moves. The Disable Auto-Reply option above takes precedence over this option. The default value is 0 on all devices.</p>
<b>bit_6</b>	64	<p>Enable Message IDs</p> <p>A value of 1 enables Message IDs. In this mode of communication, only bytes 3 through 5 are used for data. Byte 6 is used as an ID byte that the user can set to any value they wish. It will be returned unchanged in the reply. Message IDs allow the users application to monitor communication packets individually to implement error detection and recovery. The default value is 0 on all devices. Prior to firmware version 5.06, this feature was called "Virtual Channels Mode" and did not behave reliably. We do not recommend enabling this mode of communications unless you have firmware version 5.06 or later.</p>
<b>bit_7</b>	128	<p>Home Status</p> <p>This bit is set to 0 automatically on power-up or reset. It is set automatically when the device is homed or when the position is set using command #45. It can be used to detect if a device has a valid position reference. It can also be set or cleared by the user.</p>
<b>bit_8</b>	256	<p>Disable Auto-Home</p> <p>A value of 1 disables auto-home checking. Checking for trigger of home sensor is only done when home command is issued. This allows rotational devices to move multiple revolutions without re-triggering the home sensor.</p>
<b>bit_9</b>	512	<p>Reverse Potentiometer</p> <p>A value of 1 reverses the direction of the travel when the potentiometer is used to control the device. This mode bit was introduced in firmware version 5.06. Prior to that it was not used.</p>
<b>bit_10</b>	1,024	Reserved
<b>bit_11</b>	2,048	<p>Microstepping Mode</p> <p>A value of 1 enables circular phase microstepping. A value of 0 enables square phase microstepping mode. The differences are:</p> <p>Circular Phase:</p> <ul style="list-style-type: none"> <li>constant torque</li> <li>smoothest operation</li> <li>better microstep accuracy</li> <li>only 70% torque (and lower power consumption)</li> </ul> <p>Square Phase:</p> <ul style="list-style-type: none"> <li>non constant torque</li> <li>less smooth operation</li> <li>poorer microstep accuracy</li> <li>100% torque achieved (and higher power consumption)</li> </ul>
<b>bit_12</b>	4,096	Reserved
<b>bit_13</b>	8,192	Reserved
<b>bit_14</b>	16,384	<p>Disable Power LED</p> <p>A value of 1 turns off the green power LED. It will still blink briefly, immediately after powerup.</p>
<b>bit_15</b>	32,768	<p>Disable Serial LED</p> <p>A value of 1 turns off the yellow serial LED.</p>

\*Anti-backlash and Anti-sticktion routines are designed to compensate for backlash and sticktion. The solution to backlash is to always approach a position from the same direction. The solution to sticktion is to move the device far enough away from the final position to break free of sticktion before attempting the final move. The operation of the two features are dependent on each other, and the interaction of enabling one or both of the features is described in the diagram to the right.

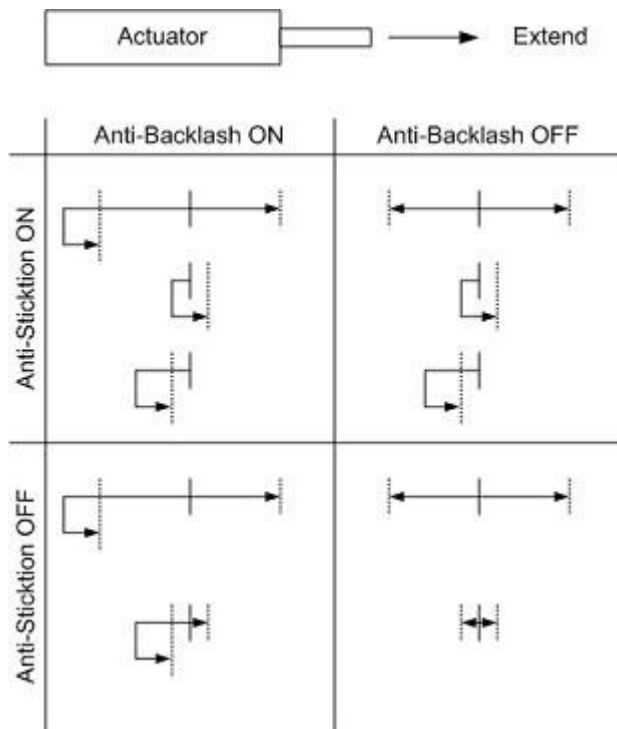

For each setting scenario, the starting position is denoted by the solid vertical line and the final position is denoted by the dotted vertical line. There are four possible moves for each scenario: long move positive, long move negative, short move positive and short move negative. The arrows show the path that would be traversed for each scenario.

## 7.17. Set Home Speed - Cmd 41

Instruction Name	Set Home Speed
Applies to	T-Series motorized devices
Firmware Version	5.xx since 5.20
Command Number	41
Command Type	Setting
Command Data	Speed
Reply Data	Speed
Safe to retry?	Yes
Returns Current Position?	No
Persistence	Non-Volatile
Summary	Sets the speed at which the device moves when using the "Home" command.

When a home instruction is issued, the device will accelerate at a rate determined by the acceleration setting up to the speed determined by this command. The home speed can be set independently of target speed (command 42) so that for stages that move very fast, issuing the home command would use a slower home speed and prevent the stage from crashing into the home position.

For a spreadsheet that can be used to calculate speed setting values for any product see <https://www.zaber.com/documents/ZaberSpeedSetting.xls>. Alternatively you may use the formulas below.

### Actual Speed

$$= \text{Data} * 9.375 * M \quad \text{mm/s or deg/s}$$

$$= \text{Data} * 9.375 \quad \text{microsteps/s}$$

$$= \text{Data} * 9.375 / R \quad \text{steps/s}$$

$$= \text{Data} * 9.375 / (R * S) * 60 \quad \text{revolutions/min} \quad \text{Motor rpm}$$

$$= \text{Data} * 9.375 * L / (R * S) \quad \text{mm/s} \quad \text{Linear devices only}$$

where:

- Data is the value of the command data
- R (microsteps/step) is the microstep resolution (command 37)
- S (steps/revolution) is the number of steps per motor revolution
- M (mm or deg) is the microstep size
- L (mm or deg) is the distance of linear motion per motor revolution

Refer to product specifications for the distance corresponding to a single microstep or revolution.

For example, if a motor has 48 steps per revolution (S = 48), used with default resolution (R = 64),



and Data is 2922, then the motor will move at a speed of approximately 535 revolutions per minute.

Valid data values are from 1 to (512×R–1).

## 7.18. Set Target Speed - Cmd 42

Instruction Name Set Target Speed	
Applies to	T-Series motorized devices
Firmware Version	5.xx
Command Number	42
Command Type	Setting
Command Data	Speed
Reply Data	Speed
Safe to retry?	Yes
Returns Current Position?	No
Persistence	Non-Volatile
Summary	Sets the speed at which the device moves when using the "Move Absolute" or "Move Relative" commands.

When a move absolute or move relative instruction is issued, the device will accelerate at a rate determined by the acceleration setting up to the speed determined by this command.

The target velocity may be changed on-the-fly even when the device is in the middle of a move. The device will automatically adjust the velocity, but still target the final position specified in the original move.

For a spreadsheet that can be used to calculate speed setting values for any product see <https://www.zaber.com/documents/ZaberSpeedSetting.xls>. Alternatively you may use the formulas below.

### Actual Speed

$$= \text{Data} * 9.375 * M \quad \text{mm/s or deg/s}$$

$$= \text{Data} * 9.375 \quad \text{microsteps/s}$$

$$= \text{Data} * 9.375 / R \quad \text{steps/s}$$

$$= \text{Data} * 9.375 / (R * S) * 60 \quad \text{revolutions/min} \quad \text{Motor rpm}$$

$$= \text{Data} * 9.375 * L / (R * S) \quad \text{mm/s} \quad \text{Linear devices only}$$

where:

- Data is the value of the command data
- R (microsteps/step) is the microstep resolution (command 37)

- S (steps/revolution) is the number of steps per motor revolution
- M (mm or deg) is the microstep size
- L (mm or deg) is the distance of linear motion per motor revolution

Refer to product specifications for the distance corresponding to a single microstep or revolution.

For example, if a motor has 48 steps per revolution (S = 48), used with default resolution (R = 64), and Data is 2922, then the motor will move at a speed of approximately 535 revolutions per minute.

Valid data values are from 0 to (512×R−1). In Firmware 5.21 and 5.22, a value of 0 is not allowed. In all other versions, target speed of 0 will cause Move Absolute/Relative and Move to Stored Position commands to return an error.

## 7.19. Set Acceleration - Cmd 43

Instruction Name	Set Acceleration
Applies to	T-Series motorized devices
Firmware Version	5.xx
Command Number	43
Command Type	Setting
Command Data	Acceleration
Reply Data	Acceleration
Safe to retry?	Yes
Returns Current Position?	No
Persistence	Non-Volatile
Summary	Sets the acceleration used by the movement commands.

When a movement command is issued, the device will accelerate at a rate determined by this command "Set Acceleration" up to a maximum speed determined by the target velocity. The acceleration may be changed on-the-fly even when the device is in the middle of a move. To determine the acceleration that will result from a given data value, the following formulas may be used:

$$\text{Actual Acceleration} = 11250 * \text{Data} * M \text{ mm/s}^2 \text{ or deg/s}^2 = 11250 * \text{Data} \text{ microsteps/s}^2 = 11250 * \text{Data} / R \text{ steps/s}^2$$

Where:

- Data is the value specified in the Command Data
- M (mm or deg) is the microstep size
- R is the microstep resolution set in command #37 (microsteps/step)

The maximum value allowable is  $(512 \cdot R - 1)$ . This is the same as the maximum allowable data for velocity, which means that the device will reach maximum velocity immediately. If acceleration is set to 0, it is as if acceleration is set to  $(512 \cdot R - 1)$ . Effectively acceleration is turned off and the device will start moving at the target speed immediately.

## 7.20. Set Maximum Position - Cmd 44

Instruction Name	Set Maximum Position
Applies to	T-Series motorized devices
Firmware Version	5.xx
Command Number	44
Command Type	Setting
Command Data	Range
Reply Data	Range
Safe to retry?	Yes
Returns Current Position?	No
Persistence	Non-Volatile
Summary	Sets the maximum position the device is allowed to travel to.

Use this command to limit the range of travel to a value other than the default. Exercise caution when using this command, since it is possible to set the range to a value greater than the physical limits of the device.

A device within range of travel is not allowed to move above its Maximum Position. Valid values can be any number from 0 to 16777215.

The behaviour of this command depends on the firmware version:

### 5.01 - 5.20

Device movement behaviour when out of range is not well-defined.

### 5.21 - 5.22

The new Maximum Position cannot be less than the current position.

### 5.23 and up

If the device Current Position is out of range and above Maximum Position, the device is not allowed to move in the positive direction.

This setting is stored in non-volatile memory and will persist after power-down or reset.

NOTE: This command was previously named Set Maximum Range.

## 7.21. Set Current Position - Cmd 45

Instruction Name	Set Current Position
Applies to	T-Series motorized devices
Firmware Version	5.xx
Command Number	45
Command Type	Setting
Command Data	New Position
Reply Data	New Position
Safe to retry?	Yes
Returns Current Position?	Yes
Persistence	Volatile
Summary	Sets the device internal position counter.

This command override the internal position counter with a new position value specified by the user.

The position data is volatile and will not persist after power-down or reset.

The phase of the stepper motor is controlled by the least significant byte of the position, thus the device may move by +/- 2 full steps unless the new position corresponds to the true current position of the device. This command is useful if you want to turn off the system without losing position. Simply save the position in the controlling computer and turn off the hold current (Command 39) before powering down. After powering up, set the position back to the saved value and turn on the hold current. In this way you can continue without having to home the device. You have to turn off the hold current because when the power first comes on the position will default to the maximum range, and that may be out of phase with the motor's current position. If the hold current is on, it will force the motor into phase with the default position before you've had a chance to restore the current position.

In Firmware 5.21 and 5.22, the new Current Position must be equal or less than Maximum Position. See Set Maximum Position (Cmd 44) for more details on range settings and behaviour.

## 7.22. Set Maximum Relative Move - Cmd 46

Instruction Name	Set Maximum Relative Move
Applies to	T-Series motorized devices
Firmware Version	5.xx
Command Number	46
Command Type	Setting
Command Data	Range
Reply Data	Range
Safe to retry?	Yes
Returns Current Position?	No
Persistence	Non-volatile
Summary	Sets a limit on the number of microsteps the device can make for a Relative Move command.

Use this command to limit the maximum range of travel for a relative move command. For example, if maximum relative move is set to 1000, and the user requests a relative move (#21) of 800, then the device will move 800 microsteps. However, if the user requests a relative move of 1200, then the device will reply with an error code. Most applications can leave this unchanged from the default.

This setting is stored in non-volatile memory and will persist after power-down or reset.

## 7.23. Set Home Offset - Cmd 47

Instruction Name	Set Home Offset
Applies to	T-Series motorized devices
Firmware Version	5.xx
Command Number	47
Command Type	Setting
Command Data	Offset
Reply Data	Offset
Safe to retry?	Yes

Returns Current Position?	No
Persistence	Non-Volatile
Summary	Sets the the new "Home" position which can then be used when the Home command is issued.

When the home command is issued, the device will retract until the home sensor is triggered, then move forward until the home sensor is no longer triggered, then move forward by the Home Offset value (in microsteps) and resets the internal position (to 0 for most devices).

Note that the home offset command also changes the range settings of the device. For example, if the initial Home Offset is 0 and the Maximum Position is 500,000, and the user changes the Home Offset to 70,000, then the Maximum Position is automatically adjusted to be 430,000. However, changing the Maximum Position does not affect the home offset.

When a new Home Offset is specified, Maximum Position is adjusted to provide the same maximum location. However, the device will not be able to travel below its new home position unless it is homing.

This setting is stored in non-volatile memory and will persist after power-down or reset.

## 7.24. Set Alias Number - Cmd 48

Instruction Name	Set Alias Number
Applies to	All Zaber devices
Firmware Version	5.00 and up
Command Number	48
Command Type	Setting
Command Data	Alias Number
Reply Data	Alias Number
Safe to retry?	Yes
Returns Current Position?	No
Persistence	Non-Volatile
Summary	Sets an alternate device number for a device.

This setting specifies an alternate device number for a device (in addition to its actual device number). By setting several devices to the same alias number, you can control a group of devices with a single instruction. When you send an instruction to an alias number, all devices with that alias number will execute the instruction and reply using their actual device numbers. To remove

an alias, simply set the device's alias number to zero. Valid alias numbers are 0 to 99 for version 6.05, and 0 to 254 otherwise. To avoid confusion, it is best to choose an alias greater than the number of devices connected.

This setting is stored in non-volatile memory and will persist after power-down or reset.

## 7.25. Set Lock State - Cmd 49

Instruction Name	Set Lock State
Applies to	T-Series devices
Firmware Version	5.xx since 5.07
Command Number	49
Command Type	Setting
Command Data	Lock State
Reply Data	Lock State
Safe to retry?	Yes
Returns Current Position?	No
Persistence	Non-Volatile
Summary	Locks or unlocks all non-volatile settings.

Sometimes it is desirable to lock all non-volatile settings to prevent them from being changed inadvertently. After changing all settings as desired, settings can be locked by setting the Lock State to 1. Subsequent attempts to change any non-volatile setting (e.g., Set Target Speed, command 42) will result in an error response with an error code of 3600 (settings locked). Note that the Set Lock State command does not apply to commands and settings that are specific to the T-JOY3 joystick. Load Event Instruction and Set Axis Device Number for example, are unaffected by the Lock State.

How the Restore Settings instruction behaves when the settings are locked depends on the firmware version. In version 5.07 issuing a Restore Settings instruction while the settings are locked will result in an error response with an error code of 3600 (settings locked). This behavior was found to confuse many customers so in version 5.08 and up, the behavior was changed such that regardless of the current lock state, issuing a Restore Settings instruction will always return setting values to factory default values and leave settings in an unlocked state.

Settings can also be unlocked by setting the Lock State to 0.

## 7.26. Return Device ID - Cmd 50

Instruction Name	Return Device ID
Applies to	All Zaber devices
Firmware Version	5.00 and up
Command Number	50
Command Type	Read-Only Setting
Command Data	Ignored
Reply Data	Device ID
Safe to retry?	Yes
Returns Current Position?	No
Persistence	n/a
Summary	Returns the ID number for the type of device connected.

See the Zaber support web site for a table of device IDs for all Zaber products.

## 7.27. Return Firmware Version - Cmd 51

Instruction Name	Return Firmware Version
Applies to	All Zaber devices
Firmware Version	5.00 and up
Command Number	51
Command Type	Read-Only Setting
Command Data	Ignored
Reply Data	Version
Safe to retry?	Yes
Returns Current Position?	No
Persistence	n/a
Summary	Returns the firmware version installed on the device.

A decimal is assumed before the last two digits. For example, 502 indicates firmware version 5.02.



## 7.28. Return Power Supply Voltage - Cmd 52

Instruction Name	Return Power Supply Voltage
Applies to	All Zaber devices
Firmware Version	5.00 and up
Command Number	52
Command Type	Read-Only Setting
Command Data	Ignored
Reply Data	Voltage
Safe to retry?	Yes
Returns Current Position?	No
Persistence	n/a
Summary	Returns the voltage level of the device's power supply.

A decimal is assumed before the last digit. For example, a value of 127 indicates 12.7 V. Note that the internal voltage measurement is not very accurate. Don't be alarmed if the indicated voltage is slightly different from your measurements.

## 7.29. Return Setting - Cmd 53

Instruction Name	Return Setting
Applies to	All Zaber devices
Firmware Version	5.00 and up
Command Number	53
Command Type	Command
Command Data	Setting Number
Reply Data	Setting Value
Safe to retry?	Yes
Returns Current Position?	No
Persistence	n/a
Summary	Returns the current value of the setting specified in the Command Data.

Valid command data values are the command numbers of any "Set..." instruction. The device will reply using the command number of the specified setting (as if a command to change the setting

had just been issued) but the setting will not be changed.

For example, command #48 is the "Set Alias" instruction. Therefore if you wish to return the current value of the alias number, simply send the Return Setting instruction with data of 48. The device will reply with command #48 and data equal to the setting value.

Since firmware version 5.21, this command also accepts the command numbers of any "Return..." instruction, such as command #50 "Return Device ID".

### 7.30. Return Status - Cmd 54

Instruction Name	Return Status
Applies to	T-Series motorized devices
Firmware Version	5.xx
Command Number	54
Command Type	Read-Only Setting
Command Data	Ignored
Reply Data	Status
Safe to retry?	Yes
Returns Current Position?	No
Persistence	n/a
Summary	Returns the current status of the device.

Possible status codes are as follows:

- 0 - idle, not currently executing any instructions
- 1 - executing a home instruction
- 10 - executing a manual move (i.e. the manual control knob is turned)
- 18 - executing a move to stored position instruction (FW 5.04 and up only)
- 20 - executing a move absolute instruction
- 21 - executing a move relative instruction
- 22 - executing a move at constant speed instruction
- 23 - executing a stop instruction (i.e. decelerating)

## 7.31. Echo Data - Cmd 55

Instruction Name	Echo Data
Applies to	All Zaber devices
Firmware Version	5.04 and up
Command Number	55
Command Type	Command
Command Data	Data
Reply Data	Data
Safe to retry?	Yes
Returns Current Position?	No
Persistence	n/a
Summary	Echoes back the same Command Data that was sent.

This command is useful for testing communication, similar to a network "ping".

## 7.32. Return Current Position - Cmd 60

Instruction Name	Return Current Position
Applies to	All motorized devices
Firmware Version	5.00 and up
Command Number	60
Command Type	Read-Only Setting
Command Data	Ignored
Reply Data	Position
Safe to retry?	Yes
Returns Current Position?	Yes
Persistence	n/a
Summary	Returns the current absolute position of the device in microsteps.

This is equivalent to issuing a Return Setting (#53) command with a command data value of 45 (Set Current Position).

## 8. Reply-Only Reference

In general, a Zaber device will reply to an instruction using the same command number as the instruction itself. However, there are occasions (such as when the user turns a manual control knob) when the device may transmit data without first receiving a request from the controlling computer. This type of reply may be considered to be a triggered reply as opposed to a requested reply. In this case the device uses a "reply-only" command number to distinguish the reply from those requested by the controlling computer. The meanings of these replies and their corresponding data are given below.

### 8.1. Move Tracking - Cmd 8

Instruction Name	Move Tracking
Applies to	T-Series motorized devices
Firmware Version	5.xx
Command Number	8
Command Type	Reply
Command Data	n/a
Reply Data	Position
Safe to retry?	Yes
Returns Current Position?	Yes
Persistence	n/a
Summary	Indicates to the user that the device has been set to a position tracking mode and given a move instruction.

Move Tracking has been enabled (see Set Device Mode (Cmd 40)) and device has been given a move instruction. In this mode, the device sends this reply every 0.25 seconds updating the current absolute position (in microsteps) during any move.

## 8.2. Limit Active - Cmd 9

Instruction Name	Limit Active
Applies to	All motorized devices
Firmware Version	5.00 and up
Command Number	9
Command Type	Reply
Command Data	n/a
Reply Data	Position
Safe to retry?	Yes
Returns Current Position?	Yes
Persistence	n/a
Summary	Indicates to the user that the device has reached one of the limits of travel.

This response from a device indicates that a "move at constant speed" command has finished. Generally this is because the device reached one of the limits of travel (either the minimum position or maximum position), but it also occurs if the device is ordered to move at constant speed zero.

## 8.3. Manual Move Tracking - Cmd 10

Instruction Name	Manual Move Tracking
Applies to	T-Series motorized devices
Firmware Version	5.xx
Command Number	10
Command Type	Reply
Command Data	n/a
Reply Data	Position
Safe to retry?	Yes
Returns Current Position?	Yes
Persistence	n/a
Summary	A reply that is sent when the manual control knob is turned.

Manual Move Tracking has been enabled (see Set Device Mode (Cmd 40)) and the device has

been moved manually (the knob is turned). In this mode, the device sends this reply every 0.25 seconds updating the current absolute position (in microsteps) during any move.

## 8.4. Error - Cmd 255

Instruction Name	Error
Applies to	T-Series motorized devices
Firmware Version	5.xx
Command Number	255
Command Type	Reply
Command Data	n/a
Reply Data	Error Code
Safe to retry?	Yes
Returns Current Position?	No
Persistence	n/a
Summary	Indicates to the user that an error has occurred.

This reply indicates that an error has occurred. The error code returned in the data indicates the type of error. The device may send an error code as a reply to an invalid instruction, or it may autonomously send an error code as a triggered reply (i.e. not in response to an instruction). The error code is typically the command number of the instruction that caused the error, but not always.

### Error Codes

Code	Name	Description
1	Cannot Home	Home - Device has traveled a long distance without triggering the home sensor. Device may be stalling or slipping.
2	Device Number Invalid	Renumbering data out of range.
14	Voltage Low	Power supply voltage too low.
15	Voltage High	Power supply voltage too high.
18	Stored Position Invalid	The position stored in the requested register is no longer valid. This is probably because the maximum range was reduced.
20	Absolute Position Invalid	Move Absolute - Target position out of range.
21	Relative Position Invalid	Move Relative - Target position out of range.

22	Velocity Invalid	Constant velocity move. Velocity out of range.
36	Peripheral Id Invalid	Restore Settings - peripheral id is invalid. Please use one of the peripheral ids listed in the user manual, or 0 for default.
37	Resolution Invalid	Invalid microstep resolution. Resolution may only be 1, 2, 4, 8, 16, 32, 64, 128.
38	Run Current Invalid	Run current out of range. See command 38 for allowable values.
39	Hold Current Invalid	Hold current out of range. See command 39 for allowable values.
40	Mode Invalid	Set Device Mode - one or more of the mode bits is invalid.
41	Home Speed Invalid	Home speed out of range. The range of home speed is determined by the resolution.
42	Speed Invalid	Target speed out of range. The range of target speed is determined by the resolution.
43	Acceleration Invalid	Target acceleration out of range. The range of target acceleration is determined by the resolution.
44	Maximum Range Invalid	The maximum range may only be set between 1 and the resolution limit of the stepper controller, which is 16,777,215.
45	Current Position Invalid	Current position out of range. Current position must be between 0 and the maximum range.
46	Maximum Relative Move Invalid	Max relative move out of range. Must be between 0 and 16,777,215.
47	Offset Invalid	Home offset out of range. Home offset must be between 0 and maximum range.
48	Alias Invalid	Alias out of range.
49	Lock State Invalid	Lock state must be 1 (locked) or 0 (unlocked).
53	Setting Invalid	Return Setting - data entered is not a valid setting command number. Valid setting command numbers are the command numbers of any "Set ..." instructions.
64	Command Invalid	Command number not valid in this firmware version.
255	Busy	Another command is executing and cannot be pre-empted. Either stop the previous command or wait until it finishes before trying again.
1600	Save Position Invalid	Save Current Position register out of range (must be 0-15).
1601	Save Position Not Homed	Save Current Position is not allowed unless the device has been homed.
1700	Return Position Invalid	Return Stored Position register out of range (must be 0-15).
1800	Move Position Invalid	Move to Stored Position register out of range (must be 0-15).
1801	Move Position Not Homed	Move to Stored Position is not allowed unless the device has been homed.

2146	Relative Position Limited	Move Relative (command 20) exceeded maximum relative move range. Either move a shorter distance, or change the maximum relative move (command 46).
3600	Settings Locked	Must clear Lock State (command 49) first. See the Set Lock State command for details.
4008	Disable Auto Home Invalid	Set Device Mode - this is a linear actuator; Disable Auto Home is used for rotary actuators only.
4010	Bit 10 Invalid	Set Device Mode - bit 10 is reserved and must be 0.
4012	Home Switch Invalid	Set Device Mode - this device has integrated home sensor with preset polarity; mode bit 12 cannot be changed by the user.
4013	Bit 13 Invalid	Set Device Mode - bit 13 is reserved and must be 0.

## 9. Manual Control

Turning the potentiometer knob will make the device move. It is not necessary to have a computer connected to use the device in manual mode. However, without a computer connected you have no means to initialize the device with a starting position. Therefore you must retract it completely after each power up in order to home the device. You will not be able to extend it fully until you have first retracted it completely to set the home position. Clockwise rotation of the knob produces positive motion (extension) and counter clockwise rotation produces negative motion (retraction).

The speed of retraction or extension will be directly related to the amount to which the knob is turned from its center detent position (turning the knob to its center position will stop the device from moving). During manual moves, the device constantly returns its position so a computer can track the position even when you are controlling the device manually. Manual control can be disabled with a mode setting.

The speed of the potentiometer-controlled manual moves is also determined by the Set Target Velocity command (#42). When the knob is fully turned to either limit, the device will move at the maximum velocity set by command #42. Any intermediate position of the knob will move the device at a velocity proportional to how far the knob has been turned. If the velocity is set to be very small, it may appear that turning the knob produces no movement. The way to verify that the actuator is moving is to connect it to a computer and monitor the replies back to the computer.

During operation if the actuator is extended or retracted against a force greater than its thrust capability the device will stall and there will be "missed steps". This can result in an apparent malfunction in that the device believes its position to be other than it actually is and will not extend or retract the actuator past a given position. Without connecting a computer to home the device or set its position, the only solution is to retract the actuator until it activates the internal home switch, which will automatically zero the device at the home position. A problem arises if the device incorrectly believes its position to be zero since it will not retract to the home position. In this case you must disconnect and reconnect the power before manually homing the device.



## 10. LED functions

The green LED is on whenever there is power to the device. A constant blinking (2Hz) of the green LED indicates that the power supply is out of range. The green LED may be disabled by a mode bit (see command #40)

The amber or red LED flashes when there is traffic packet on the RS232 line. It also stays on while the device is moving. When the potentiometer is turned, the amber or red LED will blink at a rate that is proportional to how far the potentiometer is turned. The farther the knob is turned away from center detent, the faster the LED will blink. If the device reaches either the home or the away limit while under manual control, the LED will blink slowly to indicate that the device cannot move any farther.

## 11. Troubleshooting T-Series Motion Devices

Symptom	Check
After the device finishes a move command, it starts moving again on its own.	The potentiometer knob is probably not centered. Make sure the knob is set to the middle position. You can feel a slight detent in the middle of its rotation.
Two or more devices both respond to commands sent to device 1.	Most devices are shipped with their device number set as 1. If you connect the devices through Zaber Console, you will be prompted to renumber them. If you aren't able to install and open Zaber Console, send the Renumber Instruction (command 2) in the software you are using to set all of the device numbers to different values.
Device starts turning as soon as the power is on or amber LED blinks all the time	The potentiometer is probably not centered. Turn the knob slowly until you feel the center detent.
Nothing happens when I turn the potentiometer knob either way.	Manual control may have been disabled. Issue the Restore Settings Instruction (command 36) or enable the potentiometer using the Set Device Mode Instruction (command 40).
Nothing happens when I send a move instruction.	The device needs to be "homed" first. You must issue the Home Instruction (command 1) after power up to home the device.
When I try to move the device it just makes a noise and vibrates.	There may be too much load that the device is trying to push. The actuator stalls in this situation. Try removing the load and see if the problem goes away. You can achieve higher thrust or torque by lowering the speed of the device using the Set Target Speed Instruction (command 42).

<p>Stall condition: The device makes noise but does not move.</p>	<p>Try removing all external loads. If the device now extends and retracts normally, the problem is excessive load. Try to reduce the load or change step time and acceleration parameters to ensure the load is less than the maximum thrust. If a linear motion device is stalled in its fully extended position and remains stalled without any external load applied it means the lead screw has been over extended and is stuck. You can usually get the lead screw unstuck by pushing on it after issuing the home command. If a device is stalled (with no external load) in a position that is not fully extended then it requires servicing.</p>
<p>There is no communication between the computer and my Zaber device, the amber light does not come on or flash.</p>	<p>There are several things you should check:</p> <p>Make sure you have the correct serial port selected. Try selecting other serial ports in the software. To ensure that your serial port is working properly, you can connect the send and receive pins of the serial adaptor without connecting any devices. Use a wire to connect pins 2 and 6. Your software should echo a reply every time you send an instruction. You can view the pinout diagram <a href="#">here</a>.</p> <p>Check the baud rate, hand shaking, parity, stop bit, etc. when configuring your serial communications software. The required settings are listed in the <a href="#">Control Through The RS-232 Serial Port</a> section above. Also make sure that your serial port is not configured with a termination character (it often defaults to linefeed).</p> <p>Make sure there are no bent pins in the ends of all the data cables</p> <p>Make sure the power supply is working. Check the voltage over the DC plug to see if it measures close to the rated voltage for the supply.</p> <p>Make sure the power plug is plugged in all the way. If your device has LEDs, the green LED should light.</p> <p>If your device has a manual control knob, make sure it is centered (you should feel a detent in the center position).</p> <p>If your computer is a laptop running on batteries, try plugging in the power. Some laptops disable the serial ports when running on batteries.</p> <p>Make sure you do not have a null modem adaptor or cable in the line. The serial to mini-din adaptor comes in many varieties and many have different pin connections. Check the adaptor for continuity on the proper pins by consulting the adaptor pin-out diagram <a href="#">above</a>.</p> <p>If you encounter the problem when trying to control the device with your own software, try using one of the demo programs from our website to verify that the hardware is functioning properly.</p>
<p>My device is behaving strangely. It responds to some commands as expected but not to others.</p>	<p>Send a Restore Settings Instruction (command 36). A setting might have been inadvertently changed. If you have a T-MCA or T-CD series stepper motor controller, note that a data value should be entered with the Restore Default Settings Instruction corresponding to the Peripheral Id of the device you are controlling.</p> <p>Your computer might be set to Unicode. This is common for languages that use non-Latin based characters. Go to Control Panel/Regional and Language Options/Advanced. Select a language for non-unicode programs. This should be English or another Latin based character language.</p>
<p>The device is moving very slowly. It used to behave differently.</p>	<p>The speed settings may have been changed inadvertently. Send a Restore Settings Instruction (command 36).</p>
<p>The device is not communicating or responding to computer control. The yellow LED may be blinking.</p>	<p>If the actuator has a manual control knob, make sure the knob is centered. Turn it back and forth until you feel a click or detent. Leave the knob at the center detent position. Then turn device off and on, and try again.</p>

Green LED does not come on	Check the A/C wall plug, the voltage adaptor and its connection to the device. If the power is coming over the data cable, check the mini din connector for bent or broken pins. The amber light should turn off.
Green LED flashes	The power supply voltage is outside the specified range for your device. It may either be too low or too high. Some unregulated adaptors may produce voltages significantly in excess of their rated values. If the number of devices connected on a single power supply exceeds its current capability, the voltage may drop below the required minimum voltage. You may experience this problem when many motors on a single supply move together. The load may exceed the maximum current available, causing the voltage to drop too low. If you experience this problem with a single device on a single unregulated supply rated at over 300 mA, then the problem is probably that the supply voltage is too high.
Turning the potentiometer causes no motion.	You may be at the end of travel. This can happen due to missed steps even if the device does not appear to be fully extended. Turn the knob the other way. If the device makes noise but does not move you may be in a stall condition (especially if the device appears to be fully extended). See "Stall Condition" below. The amber light should blink when turning the knob, if not, try turning the power off and then on again. You may also have set the Target Velocity (command #42) so low that it doesn't produce any visible motion. Try using command #36 to reset the device to default settings and try again.
The amber light comes on briefly when sending a command, but the device does not move and does not return codes.	Check baud rate, hand shaking, parity, stop bit, etc. Make sure that your software does not transmit any control characters like line feed, spaces or something else. The device numbers may not be what you think they are. Issue a renumber command, make sure that the computer does not transmit anything else while the devices renumber. Check that you transmit 6 bytes and that the device number and command are valid. If you encounter the problem when trying to control the device with your own software, try using one of the demo programs from our website to verify that the hardware
The device does not send replies but otherwise works.	If you encounter the problem when trying to control the device with your own software, try using a demo program from our website to verify that the hardware is functioning properly. Make sure that the receiving part of your code or commercial package is correct. Check baud rate, etc. Check connectors for bent or broken pins.
The device sometimes returns fewer than 6 bytes.	This problem usually indicates a problem with the settings for your serial port. Some serial ports are set to automatically recognize and remove specific control characters such as carriage returns when they appear in the RS232 receive buffer. When this happens, it appears as though the device has not sent enough bytes, but really the controlling computer has just removed some before you could read them. You will need to change the serial port settings to fix the problem.

Poor repeatability or the device does not extend or retract smoothly or makes louder than normal noise during travel.

You may be skipping steps. When skipping, the device will lose position in increments of 4 full steps (not microsteps). This condition happens if the thrust needed is more than the thrust available from the device. Check that the force on the device is less than the maximum thrust. Check the voltage using the voltage command. Voltage less than the rated or recommended voltage will reduce the device's maximum thrust. Try a slower target velocity (command #42) as stepper motors produce more thrust when moving slowly. Lead screw conditions greatly affect the performance of linear motion devices. Dirt, damaged threads, no grease or too heavy grease will degrade performance and may contribute to a stall. A black residue appears on the lead screw after extended use. This can increase friction and reduce thrust. Clean the screw and re-grease it. In general if you try to move a large payload or have a large static axial load (like lifting something vertically) you will have more problems. For vertical motion the use of a counterweight, spring or rubber band can help reduce the static load and improve the performance of the device. The default value of the acceleration and target velocity are good for small to medium loads and medium speeds. For very light loads and higher speeds, or heavy loads at lower speeds, these

Symptom	Check
	parameters can be tuned. Trial and error is the best tuning technique.
The device has repeatability errors smaller than 4 full steps.	If you're not skipping steps, friction may still cause some variation when returning to a position. Depending on the exact cause, there are a couple of device modes that can reduce these errors. See the Set Device Mode command's sections on the anti-backlash and anti-sticktion routines.
A linear motion device extends and retracts smoothly but will not retract to the home (zero) position.	The device will not retract below what it believes to be the zero position. If the device has missed steps due to a previous stall condition or if the device has been set to an incorrect position, the device may incorrectly believe it is at the zero position. You can solve the problem by issuing the home command, or by turning the device on and off and manually homing it.
The device does not behave as expected when software sends it a series of commands.	It can be challenging to track down problems in a complicated script or other software. In addition to the standard techniques of debugging any software, it's also helpful to see exactly what bytes are being sent and received on the serial port. There are several tools available to display the raw data from a serial port, and <a href="http://stackoverflow.com">stackoverflow.com</a> has a list of some.

## 12. Warranty and Repair

For Zaber's policies on warranty and repair, please refer to the [Ordering Policies](#).

### 12.1. Standard products

Standard products are any part numbers that do not contain the suffix ENG followed by a 4 digit number. Most, but not all, standard products are listed for sale on our website. All standard Zaber products are backed by a one-month satisfaction guarantee. If you are not satisfied with your purchase, we will refund your payment minus any shipping charges. Goods must be in brand new saleable condition with no marks. Zaber products are guaranteed for one year. During this period Zaber will repair any products with faults due to manufacturing defects, free of charge.

### 12.2. Custom products

Custom products are any part numbers containing the suffix ENG followed by a 4 digit number. Each of these products has been designed for a custom application for a particular customer. Custom products are guaranteed for one year, unless explicitly stated otherwise. During this period Zaber will repair any products with faults due to manufacturing defects, free of charge.

### 12.3. How to return products

Customers with devices in need of return or repair should contact Zaber to obtain an RMA form which must be filled out and sent back to us to receive an RMA number. The RMA form contains instructions for packing and returning the device. The specified RMA number must be included on the shipment to ensure timely processing.

## 13. Email Updates

If you would like to receive our periodic email newsletter including product updates and promotions, please sign up online at [www.zaber.com](http://www.zaber.com) (news section). Newsletters typically include a promotional offer worth at least \$100.

## 14. Contact Information

Contact Zaber Technologies Inc by any of the following methods:

<b>Fax</b>	1-604-648-8033
<b>Mail</b>	#2 - 605 West Kent Ave. N., Vancouver, British Columbia, Canada, V6P 6T7
<b>Web</b>	<a href="http://www.zaber.com">www.zaber.com</a>
<b>Email</b>	Please visit our website for up to date email contact information.

The original instructions for this product are available at <https://www.zaber.com/manuals/T-LA>.

## 15. Appendix A: Default Settings

Please see the Zaber Support Page for default settings for this device.

# 16. Product Drawing

**ZABER**  
**T-LA Linear Actuator**  
 dimensions in mm

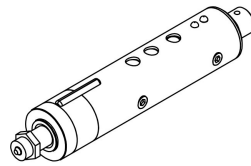

Model Number*	Travel	A	B	C	D
T-LA13A	12.5	N/A	125.5	111.8	30.5
T-LA13A-S	12.5	93.3	N/A	N/A	30.5
T-LA28A	28.0	N/A	125.5	111.8	45.5
T-LA28A-S	28.0	93.3	N/A	N/A	45.5
T-LA60A	59.5	N/A	160.5	146.8	77.5
T-LA60A-S	59.5	128.3	N/A	N/A	77.5

\*See product page for complete list of available models at [www.zaber.com](http://www.zaber.com)

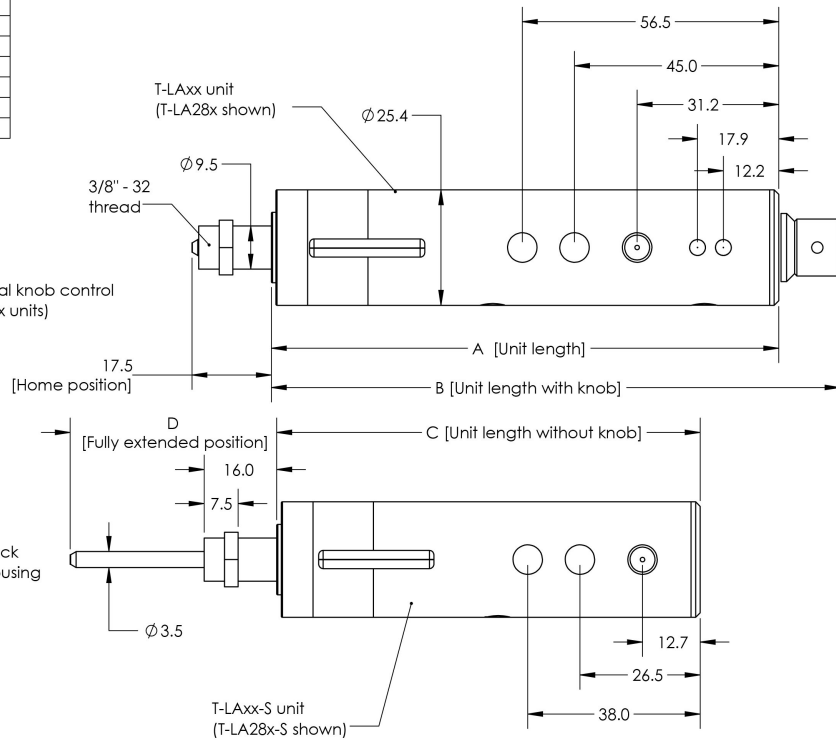
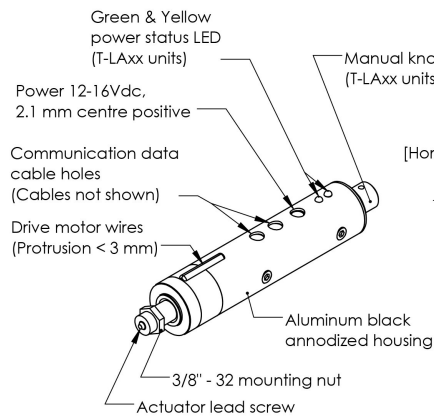

DWG 1075 001

## 17. Specifications

Specification	Value	Alternate Unit
Microstep Size (Default Resolution)	0.09921875 $\mu\text{m}$	
Built-in Controller	Yes	
Repeatability	< 4 $\mu\text{m}$	< 0.000157 "
Backlash	< 6 $\mu\text{m}$	< 0.000236 "
Maximum Speed	4 mm/s	0.157 "/s
Minimum Speed	.0009302 mm/s	0.000037 "/s
Speed Resolution	.0009302 mm/s	0.000037 "/s
Encoder Type	None	
Peak Thrust	25 N	5.6 lb
Maximum Continuous Thrust	15 N	3.4 lb
Communication Interface	RS-232	
Communication Protocol	Zaber Binary	
Maximum Current Draw	300 mA	
Power Supply	12-16 VDC	
Power Plug	2.1 mm centre positive	
Motor Temperature Rise	75 °C	
Linear Motion Per Motor Rev	0.3048 mm	0.012 "
Motor Steps Per Rev	48	
Motor Type	Stepper (2 phase)	
Inductance	55 mH/phase	
Default Resolution	1/64 of a step	
Data Cable Connection	Minidin 6	
Mechanical Drive System	Precision leadscrew	
Limit or Home Sensing	Magnetic home sensor	
Axes of Motion	1	
Mounting Interface	3/8-32 nut or 3/8" shank	
Vacuum Compatible	No	



<b>Operating Temperature Range</b>	0 to 50 °C	
<b>RoHS Compliant</b>	Yes	
<b>CE Compliant</b>	Yes	

## 17.1. Comparison

<b>Part Number</b>	<b>Travel Range</b>	<b>Accuracy (unidirectional)</b>	<b>Manual Control</b>
T-LA13A	13 mm (0.512 ")	24 µm (0.000945 ")	Yes
T-LA13A-S	13 mm (0.512 ")	24 µm (0.000945 ")	No
T-LA28A	28 mm (1.102 ")	24 µm (0.000945 ")	Yes
T-LA28A-S	28 mm (1.102 ")	24 µm (0.000945 ")	No
T-LA60A	60 mm (2.362 ")	36 µm (0.001417 ")	Yes
T-LA60A-S	60 mm (2.362 ")	36 µm (0.001417 ")	No

<b>Part Number</b>	<b>LED Indicators</b>	<b>Weight</b>	
T-LA13A	Yes	0.14 kg (0.309 lb)	
T-LA13A-S	No	0.11 kg (0.243 lb)	
T-LA28A	Yes	0.14 kg (0.309 lb)	
T-LA28A-S	No	0.11 kg (0.243 lb)	
T-LA60A	Yes	0.15 kg (0.331 lb)	
T-LA60A-S	No	0.14 kg (0.309 lb)	

## 17.2. Charts and Notes

Thrust or torque is a function of speed. The values given above are maximums. These values cannot both be achieved simultaneously (i.e. at maximum speed, the unit will not produce maximum thrust).

1. The suffix "S" designates a short unit. Manual control and LED indicators have been sacrificed on these units in favour of reduced length. All other specifications are identical to the standard unit.
2. T-LA actuators don't require hold current to maintain their position.
3. The T-LA is more delicate and has a limited lifetime compared to the T-NA08. See the image below for a lifetime vs thrust comparison.

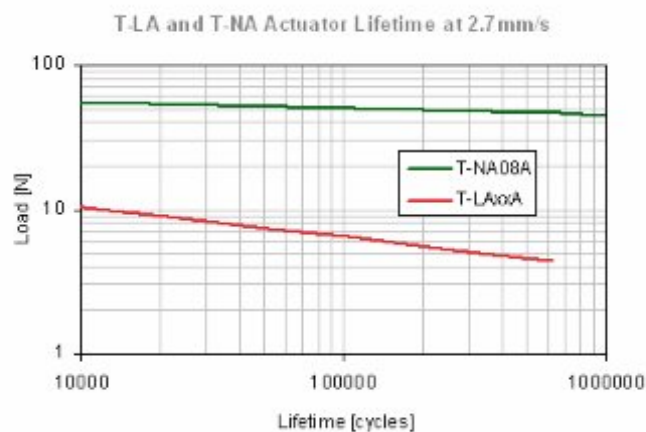
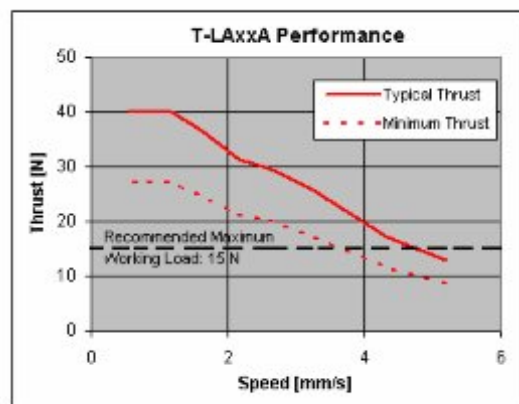

Note that the failure mode of T-LA devices is grease contamination by wear particles which effectively clog the lead-nut, although the lead screw and lead-nut remain in healthy condition. Extending the lead screw, cleaning it, and regreasing it with a silicon based grease effectively solves the problem; however, this may not be feasible in all applications. For more detailed

information, please consult the T-LA User's Manual and/or our Installation Precautions.